



ABB low voltage drives ACS550, 0.75 - 550 Hp Technical Catalog

Proudly Distributed by Gross Automation | (877) 268-3700
www.abbdriivesales.com | sales@grossautomation.com

Power and productivity
for a better world™ **ABB**

Two ways to select your drive



Choice 1: Simply contact your local ABB drives sales office and let them know what you want. Use page 5 as a reference section for more information.

OR

Choice 2: Build up your own ordering code using the simple 7-step approach below and then contact your local ABB Drive Sales Office.

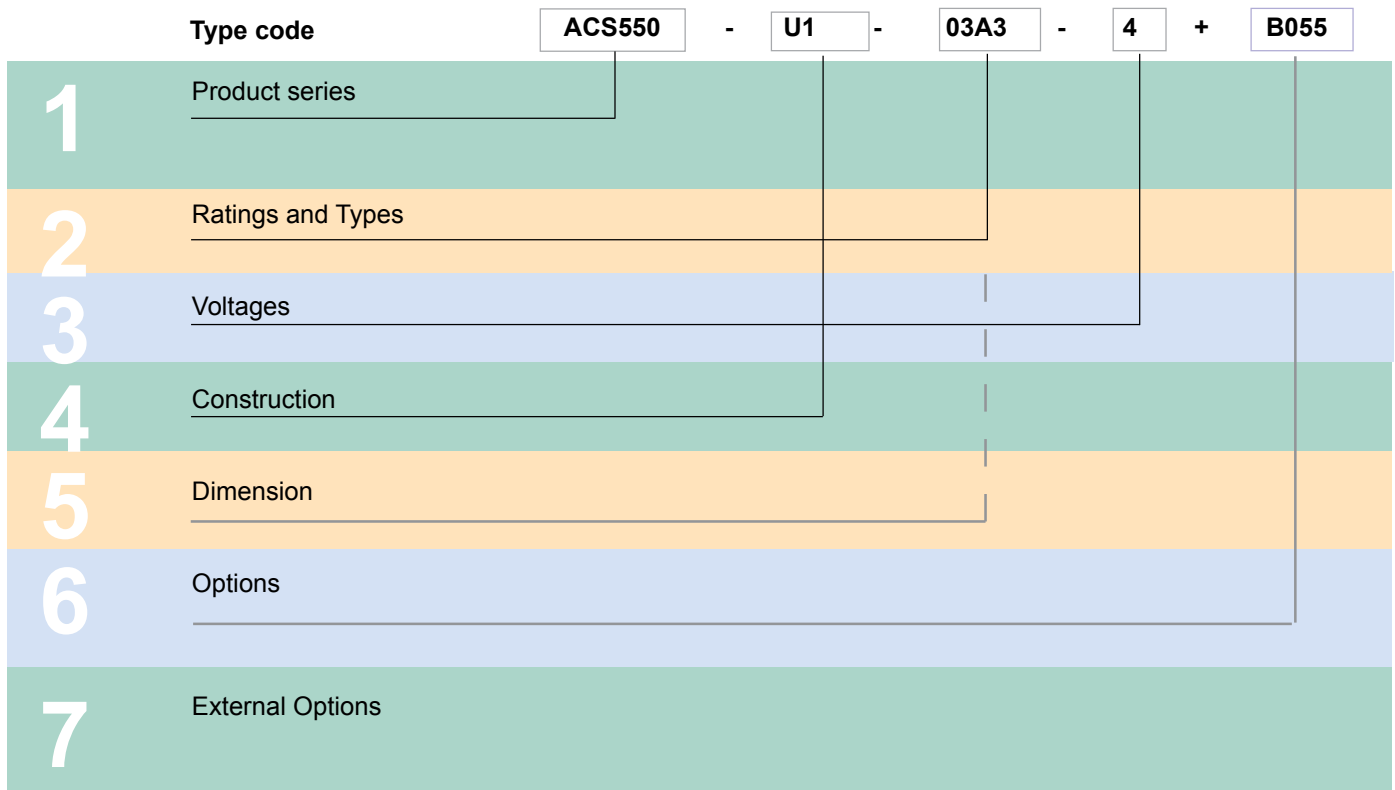

Contents

ABB Standard Drive, ACS550



ABB Standard Base Drive	4
Ratings, Types and Voltages	6
Construction	7
Advanced Control Panel	7
Options	8
Control Interfaces	
How to select options	8
Panel Mounting Kit	8
DriveWindow Light 2	8
Plug-in Options	
Relay Output Extension Option Module	9
Pulse Encoder Interface	9
Plug-in Fieldbus Module	9
115/230V Digital Interface	9
External Options	
Brake Units and Choppers	10
Technical Data	11
Cooling	12
Input Cable and Fuse Connections	13
Technical Specification	14
Control Connections	15
ABB Packaged Drives	16
Ratings, Types and Voltages	17
Dimensions	19

ABB ACS550 Standard Drive



What is the ACS550 Customer Value?

- **Reduced commissioning and installation costs**
 - Many assistants including Start-up, Drive Optimizer, Real-time Clock, Diagnostics, Maintenance, Serial and PID.
 - Two soft-keys that change according to the operator panel state
 - Field upgradeable firmware
 - Easy connection of cables
 - New conduit box is suitable for US and Europe
 - Built-in brake chopper (10Hp, 230V / 15Hp, 480V and 600 V)
 - Optional plug-in fieldbus modules
 - Reduced size and weight with Patented Swinging Choke (R1-R6) - equivalent to a 5% Line Impedance
 - 3% Impedance AC Line Reactor (R8)
 - Removable operator panel
 - Only Class T fuses required for high speed short circuit protection
 - NEMA 12 enclosure does not require derating
 - Smaller physical size of internal option slots
 - FlashDrop programming (unpowered drive)
- **Reduced energy costs without power factor penalties and correction capacitors**
 - Patented swinging choke provides substantially reduced harmonics, more inductance to the correct load and higher power factor
 - Up to 25% less THD v. traditional DC choke
 - Daily timer controls for time-of-day backoff e.g. start/stop process changes
- **Reduced Drive-Motor system failures and costs**
 - Preventative "Maintenance Assistant" annunciation feature schedules Drive-Motor system maintenance

The ABB ACS550 AC drive combines a sophisticated microprocessor with an advanced IGBT power switching technology to deliver V/Hz, Closed Loop Flux Vector and Sensorless Vector control of AC motors. Its intuitive control panel offers numerous benefits making it the most user-friendly panel in the drives industry. The extensive library of pre-programmed application macros maximizes convenience and minimizes start-up time. This drive can handle the most demanding industrial applications in an efficient, dependable and economic manner

Where can it be used?

The ABB ACS550 standard drive can be used in a wide range of industries. Typical applications include pump, fan and constant torque use, such as conveyors. The ABB ACS550 standard drive is ideal for those situations where there is a need for simplicity to install, commission and use and where customizing or special product engineering is not required.

ABB ACS550 standard drive promises

- Quick delivery
- Easy installation
- Trouble-free start-up
- Intuitive operation

Highlights:

- Advanced control panel permitting intuitive operation
- Patented swinging choke for superior harmonic reduction (R1-R4) and AC line reactor (R5-R8)
- Sensorless vector control
- Integral EMC filter as standard
- Built-in Modbus RTU and numerous internally mountable fieldbus adapters
- FlashDrop
- Coated boards for harsh environments
- UL, cUL, C-Tick and Gost-R approved
- Built-in brake chopper (10Hp, 230V / 15Hp, 480V and 600 V)
- Many assistants including Start-up, Drive Optimizer, Real-time Clock, Diagnostics, Maintenance, Serial and PID
- Seismic Certification to ICC AC-156 Criteria

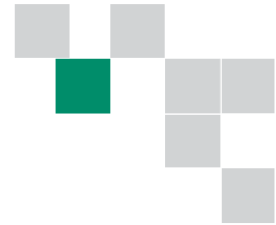

What are the ACS550's Main Features and Benefits Supporting Customer Value?

Feature	Note	Benefit
Advanced Control Panel	Two soft-keys change according to the state of the panel Built-in "Help" button Real-time clock, allows timed tracing of faults and setting of parameters at various times of day Changed parameter menu	Easy commissioning Fast set-up Easier configuration Rapid fault diagnostics Quick access to recent parameter changes
Brake Chopper	Built-in up to 15 Hp (480 and 600V) and up to 10 Hp (240V)	Reduced installation cost
Chokes	5% equivalent impedance swinging choke-matches the right inductance to the right load, suppressing and reducing harmonics (R1-R4), 3% impedance AC line reactor (R5-R8)	Reduces Total Harmonic Distortion (THD) emissions up to 25%
Connectivity	Simple to install: Easy connection of cables Easy connection of external fieldbus systems through multiple I/Os and plug-in options	Reduced installation time Secure cable connections
Assistants (v3.11a+)	Diagnostic assistant activated when fault occurs Maintenance assistant monitors running hours or motor rotation Start-up assistant guides user through all essential settings without going to parameter list and offers option for parameter backup automatically PID Controller assistant guides user set-up without going to parameter list Real-time clock assistant helps user adjust time and date functions Serial communications assistant provides a convenient way to set-up fieldbus connections Drive optimizer permits user to choose drive set-up for low noise, drive & motor efficiency or motor control accuracy	Quick fault diagnostics Takes care of drive preventative maintenance Easy set-up of parameters Simplifies closed loop process control adjustment Allows quick adjustment of time and date Provides easy set-up of fieldbus connectivity Quickly tailors drive to application
Built-in EMC	Built-in category C2 (1st environment) filter	No need for external filtering
Sensorless vector control	Improve motor control performance	Enables wider range of applications
Switching frequency control	Permits the highest possible switching frequency based on operating and ambient conditions	Considerable motor noise reduction and improved efficiency
Flashdrop	Faster and easier drive set-up and programming	New fast, safe and trouble free method to download parameters available without powering the drive - patented
Coated boards	Longer lifetime in hostile environments. Reduced servicing requirements	Protections against moisture and hostile particles as standard
Flange Mounting Kits	Allows mounting the drive with the heatsink external to a 3rd party enclosure - frame size R1-R6.	Reduces heat and enclosure size

Ratings, Types and Voltages



Type code

This is the unique reference number that clearly identifies the drive by mounting configuration, power rating and voltage. Once you have selected the type code, the frame size can be used to determine the drives dimensions, shown on the next page.

Voltages

The ACS550 is available in three voltage ranges:

- 2 = 208 - 240V
- 4 = 380 - 480V
- 6 = 500 - 600V

Notes

- 1 I_{2N} : continuous base current with 110% overload for 1 minute / 10 minutes.
- 2 I_{2hd} : continuous base current with 150% overload for 1 minute / 10 minutes.
- 3 180% I_{hd} continuous base current available for 2 seconds / 1 minute.
- 4 The rated current of the ACS550 must be greater than or equal to the rated motor current to achieve the rated motor power given in the table.
- 5 All -U1 models come with a conduit box and advanced control panel as standard.
- 6 Horsepower is based on NEMA motor ratings for most 4-pole motors (1800 rpm). Check motor nameplate current for compatibility.
- 7 All 230V product can be operated on 230V single-phase power, using a de-rate of the output current of 50%.
- 8 All -U2 models come standard with US conduit openings, top entry / top exit, common mode filter for drives larger than 200 HP, fused disconnect and extended enclosure with advanced control panel.

Type Code UL Type 1 NEMA 1	Nominal Ratings				Frame Size
	Normal Duty (CT) (110% I_{2N})		Heavy Duty (CT) (150% I_{2hd})		
	I_{2N} A ^(1,7)	P _N HP ^(4,6)	I_{2hd} A ^(2,3,7)	P _{hd} HP ^(4,6)	
ACS550-U1-04A6-2	4.6	1.0	3.5	0.75	R1
ACS550-U1-06A6-2	6.6	1.5	4.6	1.0	R1
ACS550-U1-07A5-2	7.5	2.0	6.6	1.5	R1
ACS550-U1-012A-2	11.8	3.0	7.5	2	R1
ACS550-U1-017A-2	16.7	5.0	11.8	3	R1
ACS550-U1-024A-2	24.2	7.5	16.7	5	R2
ACS550-U1-031A-2	30.8	10	24.2	7.5	R2
ACS550-U1-046A-2	46.2	15	30.8	10	R3
ACS550-U1-059A-2	59.4	20	46.2	15	R3
ACS550-U1-075A-2	74.8	25	59.4	20	R4
ACS550-U1-088A-2	88	30	74.8	25	R4
ACS550-U1-114A-2	114	40	88	30	R4
ACS550-U1-143A-2	143	50	114	40	R6
ACS550-U1-178A-2	178	60	150	50	R6
ACS550-U1-221A-2	221	75	178	60	R6
ACS550-U1-248A-2	248	100	192	75	R6
ACS550-U1-03A3-4	3.3	1.5	2.4	1	R1
ACS550-U1-04A1-4	4.1	2	3.3	1.5	R1
ACS550-U1-06A9-4	6.9	3	5.4	2	R1
ACS550-U1-08A8-4	8.8	5	6.9	3	R1
ACS550-U1-012A-4	11.9	7.5	8.8	5	R1
ACS550-U1-015A-4	15.4	10	11.9	7.5	R2
ACS550-U1-023A-4	23	15	15.4	10	R2
ACS550-U1-031A-4	31	20	23	15	R3
ACS550-U1-038A-4	38	25	31	20	R3
ACS550-U1-045A-4	44	30	38	25	R3
ACS550-U1-059A-4	59	40	44	30	R4
ACS550-U1-072A-4	72	50	59	40	R4
ACS550-U1-078A-4	77	60	65	50	R4
ACS550-U1-097A-4	96	75	77	60	R4
ACS550-U1-125A-4	124	100	96	75	R5
ACS550-U1-157A-4	157	125	124	100	R6
ACS550-U1-180A-4	180	150	156	125	R6
ACS550-U1-246A-4	245	200	192	150	R6
ACS550-U2-316A-4	316	250	240	200	R8
ACS550-U2-368A-4	368	300	302	250	R8
ACS550-U2-414A-4	414	350	368	300	R8
ACS550-U2-486A-4	486	400	414	350	R8
ACS550-U2-526A-4	526	450	477	400	R8
ACS550-U2-602A-4	602	500	515	450	R8
ACS550-U2-645A-4	645	550	590	500	R8
ACS550-U1-02A7-6	2.7	2	2.4	1.5	R2
ACS550-U1-03A9-6	3.9	3	2.7	2.0	R2
ACS550-U1-06A1-6	6.1	5	3.9	3.0	R2
ACS550-U1-09A0-6	9	7.5	6.1	5.0	R2
ACS550-U1-011A-6	11	10	9	7.5	R2
ACS550-U1-017A-6	17	15	11	10	R2
ACS550-U1-022A-6	22	20	17	15	R3
ACS550-U1-027A-6	27	25	22	20	R3
ACS550-U1-032A-6	32	30	27	25	R4
ACS550-U1-041A-6	41	40	32	30	R4
ACS550-U1-052A-6	52	50	41	40	R4
ACS550-U1-062A-6	62	60	52	50	R4
ACS550-U1-077A-6	77	75	62	60	R6
ACS550-U1-099A-6	99	100	77	75	R6
ACS550-U1-125A-6	125	125	99	100	R6
ACS550-U1-144A-6	144	150	125	125	R6

Construction



“U1” within the type code indicates the drive mounting configuration. U1 models are wall-mounted, while "U2" models are free-standing with an extended enclosure and fused disconnect. Choose the correct one for your needs from the table below:

U1	U2
<ul style="list-style-type: none"> ■ Wall mounted, frame size R1-R6 ■ 0.75 - 200 HP ■ UL Type 1 (IP21) NEMA 1 or UL Type 12 (IP54) NEMA 12 ■ Built-in EMC filter ■ Standard software ■ Built-in Modbus RTU interface ■ Cable connection box ■ Brake chopper in frame sizes R1-R2 ■ Advanced control panel ■ Swinging choke (Frames R1-R6) 	<ul style="list-style-type: none"> ■ Free standing, frame size R8 ■ 250 - 550Hp ■ UL Type 1 (IP21) NEMA 1 ■ Standard software ■ Built-in Modbus RTU interface ■ Free-standing with extended enclosure and fused disconnect ■ Advanced control panel ■ AC Reactor (Frame R8)

Advanced Control Panel

For easy drive programming, a detachable, multilingual alphanumeric advanced control panel is delivered as standard. The control panel has various assistants and built-in help functions to guide the user. It includes a real time clock, which can be used during fault logging and in

controlling the drive, such as start/stop and maintenance reminders. The control panel can be used for copying parameters for back up or for downloading to another drive. A large graphical display and soft keys make it extremely easy to navigate.

	Name	Function
	Start	Initiates operation of drive
	Stop	Ceases operation of drive
	Up	Changes parameters and their value/ increases reference
	Down	Changes parameters and their value/ decreases reference
	Loc/Rem	Changes drive state from local control to remote control (I/O or other external source)
	HELP	Built-in "Help" button
	Soft key 1	Function changes according to state of panel
	Soft key 2	Function changes according to state of panel

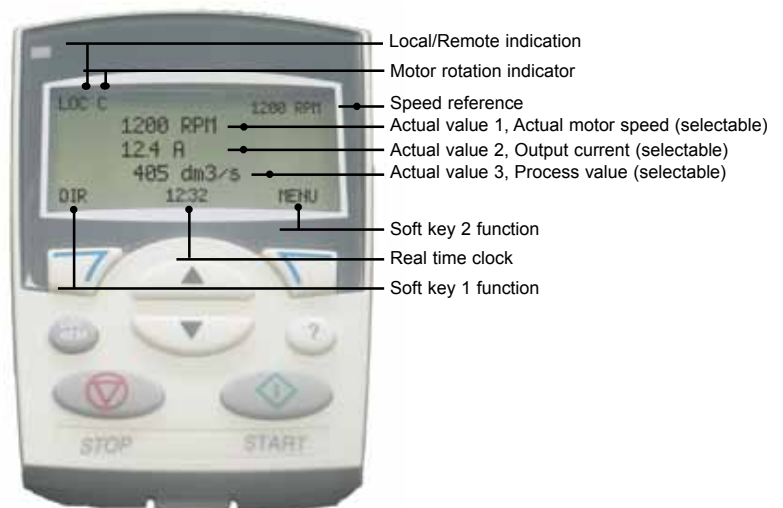

Options

Control Interfaces



How to select options

The options shown below are available for use with the ACS550. Each item has a 4-digit option code, which is shown in the table below. This code is added to the end of the type code above using a '+'. Ordering options using the plus option code provides a factory installed option, while using the field kit code provides a field installable kit (-KIT).

Available options		
Plus Option Code	Description	Field Kit Code
Protection class		
+B055	UL Type 12 (IP54) NEMA 12	
Slot 1 Options		
+L511	Relay Output Extension	OREL-01-KIT
+L502	Pulse Encoder Interface	OTAC-01-KIT
Slot 2 Options		
+L512	115/230V Digital Input Interface	OHDI-01-KIT
+K451	DeviceNet	RDNA-01-KIT
+K454	Profibus-DP	RPBA-01-KIT
+K462	ControlNet	RCNA-01-KIT
+K466	EtherNet/IP and Modbus/TCP	RETA-01-KIT
+K457	CANopen	RCAN-01-KIT
+K467	PROFINET and Modbus/TCP	RETA-02-KIT

NOTE:

- Only one option can be installed in each option slot.
- Embedded Modbus RTU

Panel Mounting Kit (OPMP-01)

The panel mounting kit, OPMP-01, enables mounting of control panels on cabinet doors. This kit includes a 10 ft (3 m) extension cable, a gasket, mounting screws and a mounting template.



ACS-CP-EXT: permits permanent mounting of panel to external surface of NEMA 1 or NEMA 12 enclosures.

ACS-CP-EXT-IP66: permits permanent mounting of panel to external surface of NEMA 4X enclosures.

DriveWindow Light 2 (3AFE64532871)

DriveWindow Light 2 is a PC software used for rapid commissioning, operating and programming of drives. It has features for programming, monitoring, troubleshooting and maintenance.

It is also a set-up and control tool which is Win98, WinNT, Win2000 and WinXP compatible.

DriveWindow Light 2 operates both off- and on-line. No additional PC hardware is required. It uses the PC's RS-232 port. It is also compatible with drive types ACS350, ACS800, DCS400 and DCS800.

DriveWindow Light 2 features

- Graphical start-up wizards
- Off- and on-line viewing and changing of drive parameters
- Backup and restore parameters. In a fault situation, the parameters can be reloaded resulting in time savings
- Graphical monitoring of actual signal values
- I/O mapping table
- Control of the drive

DrivePM

DrivePM (Parameter Manager) is a software tool designed to create, edit and copy parameter sets included with a FlashDrop. For each parameter, and parameter group, the user can change the default or hide the parameter or entire group. FlashDrop does not require the drive to have power applied. FlashDrop is also compatible with the ACS150 and ACS350.

FlashDrop MFDT-01

FlashDrop is a powerful palm-sized tool for fast and easy parameter selecting and setting. This tool can be used to download parameters to a drive in less than three seconds. Using this tool, it is possible to hide selected parameters to protect the machine. Only parameters needed in the application are shown. FlashDrop does not require the drive to be powered. The MFDT-01 includes Drive PM (Drive Parameter Manager) software tool to create, edit and copy parameter sets.



FlashDrop (MFDT-01)

Options

Plug-in Options



Relay Output Extension Module (+L511)

This plug-in option offers three additional relay outputs. They can be used to actuate motor starters for pumps using a lead-lag alternation scheme with the built-in Pump-Fan Macro. All relays can be programmed to on/off by using the advanced control panel's clock. Alternatively, fieldbus adapters can be used to control any external components in the system.

Pulse Encoder Interface (+L502)

The Pulse Encoder Interface module offers a differential or single ended interface for a digital pulse encoder connection. The module is capable of operating from either a 15 or 24 VDC signal with a maximum frequency of 200kHz.

115/230V Digital Input Interface (+L512)

The 115/230V Digital Input Interface module offers six (6) 115V or three (3) 230V rated relays mounted on a common board used to drive DI1 through DI6 of the ACS550. The 115/230V must be provided by the user. The module cannot be used in conjunction with any fieldbus module as it occupies the same option slot.

Plug-in Fieldbus Modules

The plug-in fieldbus options bring connectivity to major automation systems. A single twisted pair avoids large amounts of conventional cabling, thereby reducing cost and increasing system reliability.

The ACS550 supports the following fieldbus options:

- CANopen
- ControlNet™
- DeviceNet™
- Embedded Modbus® RTU
- EtherNet/IP™ Modbus/TCP®
- Profibus-DP®
- PROFINET IO®

NOTE:

- Only one option can be installed in each option slot.

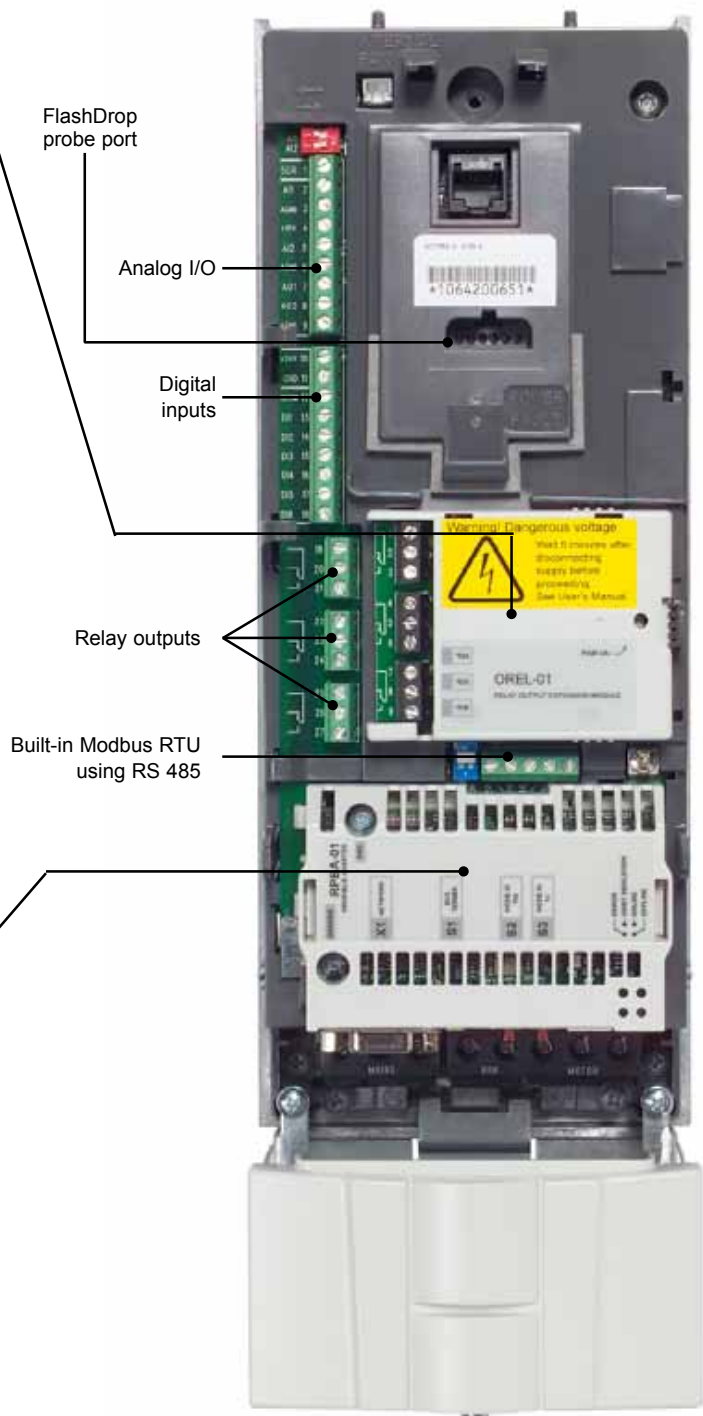

Options

External Options



Brake Units and Choppers

Frame sizes R1 to R2 are delivered with integrated brake choppers as standard. Other units can use an external brake chopper and resistor. For more information, please refer to the *ABB Low Voltage Drives PowerOhm Resistors Price List (LVD-PNPL02U-EN)*.

Flange Mounting Kits

Flange Mounting Kits for the ACS550 drives allow mounting of the drive with the heatsink external to a 3rd party enclosure. Use of the flange kit requires removal of the drive cover, reducing protection to IP00. The flange kit can be used with 3rd party UL Type 1 & 12 (NEMA 1 & 12) enclosures. R5 and R6 kits provide NEMA 1 protection only.

Flange Mounting Kits

Frame Size	Field Kit Code
R1	FMK-A-R1
R2	FMK-A-R2
R3	FMK-A-R3
R4	FMK-A-R4
R5	AC8-FLNGMT-R5
R6	AC8-FLNGMT-R6

Technical Data

Cooling



Cooling Air Flow 208 - 240V Units

Type Code	Frame Size	W	BTU/Hr	m³/h	ft³/min
-04A6-2	R1	55	189	44	26
-06A6-2	R1	73	249	44	26
-07A5-2	R1	81	276	44	26
-012A-2	R1	118	404	44	26
-017A-2	R1	161	551	44	26
-024A-2	R2	227	776	88	52
-031A-2	R2	285	973	88	52
-046A-2	R3	420	1434	134	79
-059A-2	R3	536	1829	134	79
-075A-2	R4	671	2290	280	165
-088A-2	R4	786	2685	280	165
-114A-2	R4	1014	3463	280	165
-143A-2	R6	1268	4331	405	238
-178A-2	R6	1575	5379	405	238
-221A-2	R6	1952	6666	405	238
-248A-2	R6	2189	7474	405	238

Cooling Air Flow 380 - 480V Units

Type Code	Frame Size	W	BTU/Hr	m³/h	ft³/min
-03A3-4	R1	40	137	44	26
-04A1-4	R1	52	178	44	26
-06A9-4	R1	97	331	44	26
-08A8-4	R1	127	434	44	26
-012A-4	R1	172	587	44	26
-015A-4	R2	232	792	88	52
-023A-4	R2	337	1151	88	52
-031A-4	R3	457	1561	134	79
-038A-4	R3	562	1919	134	79
-045A-4	R3	667	2278	134	79
-059A-4	R4	907	3098	280	165
-072A-4	R4	1120	3825	280	165
-078A-4	R4	1300	4300	280	165
-097A-4	R4	1440	4918	280	165
-125A-4	R5	1940	6625	350	205
-157A-4	R6	2310	7889	405	238
-180A-4	R6	2810	9897	405	238
-246A-4	R6	3850	13148	540	318
-316A-4	R8	4550	15539	1220	718
-368A-4	R8	6850	23394	1220	718
-414A-4	R8	7400	25000	1220	718
-486A-4	R8	7850	26809	1220	718
-526A-4	R8	7600	25955	1220	718
-602A-4	R8	8100	27663	1220	718
-645A-4	R8	9100	31078	1220	718

Cooling Air Flow 500 - 600V Units

Type Code	Frame Size	W	BTU/Hr	m³/h	ft³/min
-02A7-6	R2	46	157	88	52
-03A9-6	R2	68	232	88	52
-06A1-6	R2	124	423	88	52
-09A0-6	R2	170	581	88	52
-011A-6	R2	232	792	88	52
-017A-6	R2	337	1150	88	52
-022A-6	R3	457	1560	134	79
-027A-6	R3	562	1918	134	79
-032A-6	R4	667	2276	280	165
-041A-6	R4	907	3096	280	165
-052A-6	R4	1120	3820	280	165
-062A-6	R4	1295	4420	280	165
-077A-6	R6	1504	5136	405	238
-099A-6	R6	1821	6219	405	238
-125A-6	R6	2442	8339	405	238
-144A-6	R6	2813	9607	405	238

ACS550 are configured with cooling air fans. The cooling air must be free from corrosive materials with a maximum ambient temperature of 40°C (50°C with derating).

Free space requirements

Enclosure Type	Space above mm / in	Space below mm / in	Space on left and right mm / in
U1 - Wall Mount	200 / 7.9	200 / 7.9	0
U2 - Floor Mount	200 / 7.9	0	0

Technical Data



Fuse connections

Standard fuses can be used with ABB standard drives. For fuse connections see table below.

Recommended input protection fuses

Type Code	Frame Size	Input Current A	Mains Fuses	
			IEC269 gG (A)	UL Class T (A)
-04A6-2	R1	4.6	10	10
-06A6-2	R1	6.6	10	10
-07A5-2	R1	7.5	10	10
-012A-2	R1	11.8	16	15
-017A-2	R1	16.7	25	25
-024A-2	R2	24.2	25	30
-031A-2	R2	30.8	40	40
-046A-2	R3	46.2	63	60
-059A-2	R3	59.4	63	80
-075A-2	R4	74.8	80	100
-088A-2	R4	88.0	100	110
-114A-2	R4	114.0	125	150
-143A-2	R6	143.0	200	200
-178A-2	R6	178.0	250	250
-221A-2	R6	221.0	315	300
-248A-2	R6	248.0	315	350
-03A3-4	R1	3.3	10	10
-04A1-4	R1	4.1	10	10
-06A9-4	R1	6.9	10	10
-08A8-4	R1	8.8	10	15
-012A-4	R1	11.9	16	15
-015A-4	R2	15.4	16	20
-023A-4	R2	23.0	25	30
-031A-4	R3	31.0	35	40
-038A-4	R3	38.0	50	50
-045A-4	R3	44.0	50	60
-059A-4	R4	59.0	63	80
-072A-4	R4	72.0	80	90
-078A-4	R4	77.0	80	100
-097A-4	R4	96.0	125	125
-125A-4	R5	124.0	160	175
-157A-4	R6	157.0	200	200
-180A-4	R6	180.0	250	250
-246A-4	R6	245.0	250	250
-316A-4	R8	316.0	400	400
-368A-4	R8	368.0	400	400
-414A-4	R8	414.0	500	500
-486A-4	R8	486.0	500	500
-526A-4	R8	526.0	630	630
-602A-4	R8	602.0	630	630
-645A-4	R8	645.0	800	800
-02A7-6	R2	2.7	10	10
-03A9-6	R2	3.9	10	10
-06A1-6	R2	6.1	10	10
-09A0-6	R2	9.0	16	15
-011A-6	R2	11.0	16	15
-017A-6	R2	17.0	25	25
-022A-6	R3	22.0	25	25
-027A-6	R3	27.0	35	40
-032A-6	R4	32.0	35	40
-041A-6	R4	41.0	50	50
-052A-6	R4	52.0	60	60
-062A-6	R4	62.0	80	80
-077A-6	R6	77.0	80	100
-099A-6	R6	99.0	125	150
-125A-6	R6	125.0	160	175
-144A-6	R6	144.0	200	200

Technical Specification



Input power connection	
Voltage and power range	3-phase, 208 to 240 V, +10/-15%, 0.75 - 100Hp 3-phase, 380 to 480 V, +10/-15%, 1 - 550Hp 3-phase, 500 to 600V, +10/-15%, 1.5 - 150Hp
Frequency	48 to 63 Hz
Power factor	0.98

Motor connection	
Voltage	3-phase, from 0 to U_{SUPPLY}
Frequency	0 to 500 Hz
Continuous loading capability <small>(constant torque at a max ambient temperature of 40°C)</small>	Rated output current I_{2N}
Overload capacity <small>(at a max. ambient temperature of 40°C)</small>	At normal use $1.1 \times I_{2N}$ for 1 minute every 10 minutes At heavy-duty use $1.5 \times I_{2nd}$ for 1 minute every 10 minutes Always $1.8 \times I_{2nd}$ for 2 seconds every 60 seconds
Switching frequency	
Standard	Default 4 kHz
Selectable	0.75 - 150Hp 1 kHz, 4 kHz, 8 kHz, 12 kHz up to 550Hp 1 kHz, 4 kHz
Acceleration time	0.1 to 1800 s
Deceleration time	0.1 to 1800 s

Environmental limits	
Ambient temperature	-15 to 40°C (5 to 104°F) 40 to 50°C (104 to 122°F) No frost allowed f_{switch} 4 kHz, P_N and I_2 derated to 90%
Altitude	
Output current	Rated current available at 0 to 1000 m (3300 ft) reduced by 1% per 100 m over 1000 m (3300 ft) to 2000 m (6600 ft)
Relative humidity	lower than 95% (without condensation)
Protection class	UL Type 1 or 12 (NEMA 1 or NEMA 12)
Enclosure color	NCS 1502-Y, RAL 9002, PMS 420 C
Contamination levels	IEC 721-3-3
Transportation	No conductive dust allowed Class 1C2 (chemical gases), Class 1S2 (solid particles)
Storage	Class 2C2 (chemical gases), Class 2S2 (solid particles)
Operation	Class 3C2 (chemical gases), Class 3S2 (solid particles)

Motor Control	
Speed Control	
Open Loop	20% of motor nominal slip
Closed Loop	0.1% of motor nominal speed
Open Loop	< 1% s with 100% torque step
Closed Loop	0.5% s with 100% torque step
Motor Control	
Open Loop	<10ms with nominal torque
Closed Loop	<10ms with nominal torque
Open Loop	±5% with nominal torque
Closed Loop	±2% with nominal torque

Programmable control connections	
Two analog inputs	
Voltage signal	0 (2) to 10 V, $R_{in} > 312 \text{ k}\Omega$ single-ended
Current signal	0 (4) to 20 mA, $R_{in} = 100 \Omega$ single-ended
Potentiometer reference value	10 V ±2% max. 10 mA, $R < 10 \text{ k}\Omega$
Maximum delay	12...32 ms
Resolution	0.1%
Accuracy	±1%
Two analog outputs	0 (4) to 20 mA, load < 500 Ω
Accuracy	±3%
Auxiliary voltage	24 V DC ±10%, max. 250 mA
Six digital inputs	12 V... 24 V DC with internal or external supply, PNP and NPN
Input impedance	2.4 k Ω
Maximum delay	5 ms ± 1ms
Three relay outputs	
Maximum switching voltage	250 V AC/30 V DC
Maximum switching current	6 A/30 V DC; 1500 V A/230 V AC
Maximum continuous current	2 A rms
Serial communication	
RS 485	Built-in Modbus RTU protocol

Product compliance	
240V products:	UL, cUL, CSA, CE, C-TICK, and GOST-R approvals
480V products:	UL, cUL, CSA, CE, C-TICK, and GOST-R approvals
600V products:	UL, cUL, CSA, C-TICK, and GOST-R approvals
	Low Voltage Directive 73/23/EEC with supplements
	Machinery Directive 98/37/EC
	EMC Directive 89/336/EEC with supplements
	Quality assurance system ISO 9001 and Environmental system ISO 14001
	Seismic Certification to ICC AC-156

EMC according to EN61800-3	
1 st environment restricted distribution for frame sizes R3, R4 with 75 m motor cables and for frame sizes R1, R2, R5, R6 with 100 m motor cables.	
2 nd environment unrestricted distribution for frame sizes R1 - R4 with 300 m cable and for frame sizes R5 - R8 with 100 m motor cables as standard.	
These cable lengths are for EMC purposes only. For long motor cable lengths, external EMC filters are available on request.	

EMC standards in general		
EN 61800-3/A11 (2000), product standard	EN 61800-3 (2004), product standard	EN 55011, product family standard for industrial, scientific and medical (ISM) equipment
1st Environment, unrestricted distribution	Category C1	Group 1 Class B
1st Environment, restricted distribution	Category C2	Group 1 Class A
2nd Environment, unrestricted distribution	Category C3	Group 2 Class A
2nd Environment, restricted distribution	Category C4	Not Applicable

Control Connections



These connections are shown as examples only. Please refer to the *ACS550 User's Manual (3AUA000001609)* for more detailed information.

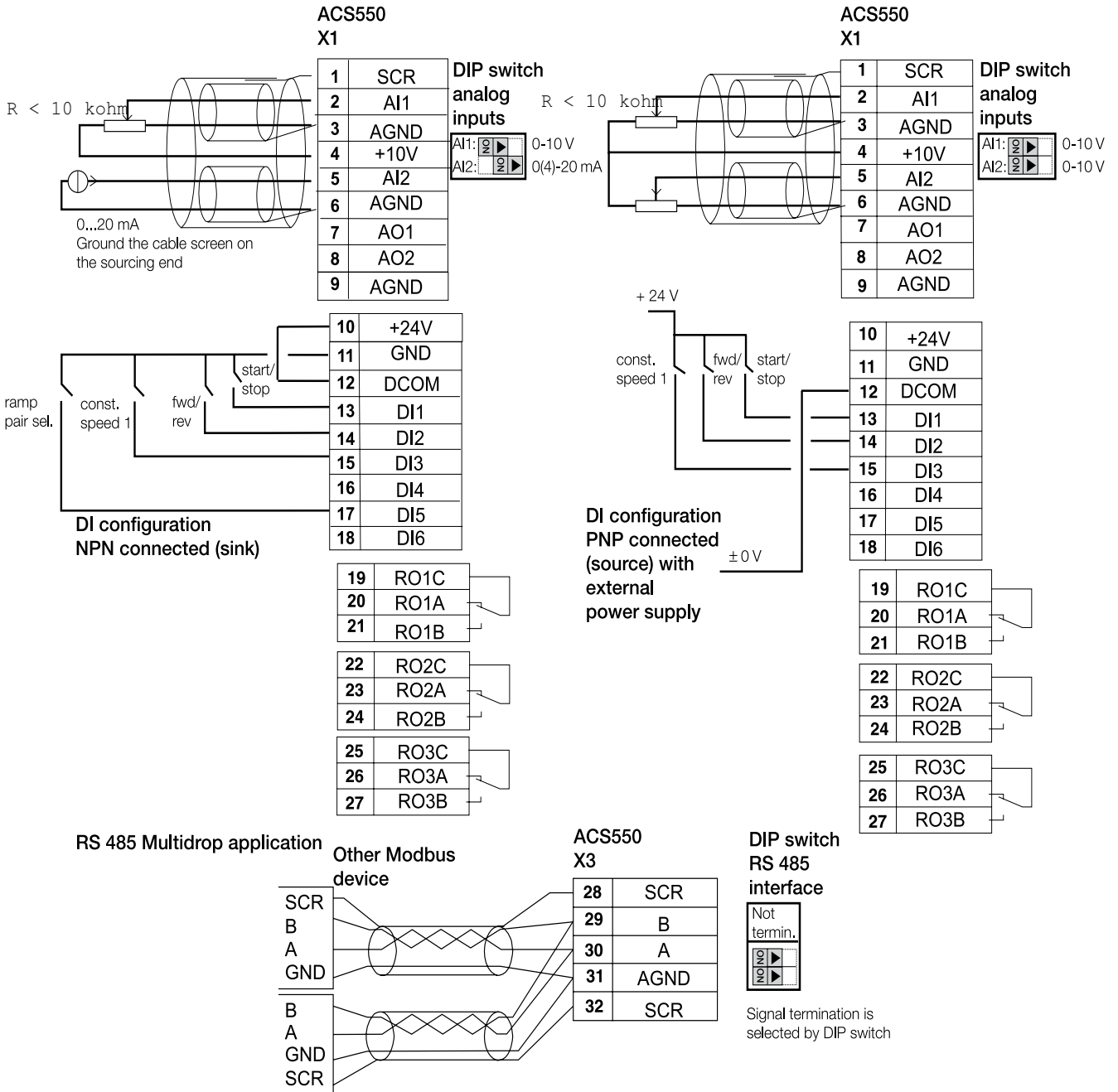

Fieldbus Control

Gateway to your process



ABB AC drives have the connectivity to major automation systems. This is achieved with a dedicated gateway concept between the fieldbus systems and ABB drives.

The fieldbus gateway is a snap-on module that can be easily mounted inside the drive. As a result of the wide range of fieldbus gateways, your choice for an automation system becomes independent of your decision to use first-class ABB AC drives.

Manufacturing Flexibility

Drive control

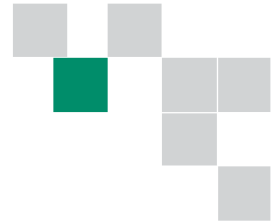
The drive Control Word (16 bit) provides a wide variety of functions from Start, Stop and Reset to Ramp Generator control. Typical setpoint values like Speed, Torque and Position can be transmitted to the drive with 15 bit accuracy.

Drive monitoring

A set of drive parameters and/or actual signals, like torque, speed, position, current etc., can be selected for cyclic data transfer providing fast data for operators and the manufacturing process.

Drive diagnostics

Accurate and reliable diagnostic information can be obtained via the drive Alarm, Limit and Fault Words reducing the down time of the drive and therefore, also the down time of the manufacturing process.

Drive parameter handling

Total integration of the drives in the production process is achieved by single parameter read/write up to complete parameter set-up or download.

Easy to expand

Serial communication simplifies the latest trend of modular machine design enabling expansion of the installation at a later stage with low effort.

Reduced Installation and Engineering Effort

Cabling

Substituting the large amount of conventional Drive Control cabling with a single twisted pair reduces costs and increases system reliability.

Design

The use of Fieldbus Control reduces engineering time at installation due to the modular structure of the hardware and software.

Commissioning and assembly

The modular machine configuration allows pre-commissioning of single machine sections and provides easy and fast assembly of the complete installation.

Currently Available Gateways

- CANopen
- ControlNet™
- DeviceNet™
- Embedded Modbus® RTU
- Modbus/TCP®
- EtherNet/IP™
- Profibus-DP®
- PROFINET IO®

ABB ACS550 Packaged Drives



ACS550 Packaged Drive

ACS550-PC and PD packaged drives combine ACS550 AC drives with the disconnect arrangement of your choice in one coordinated, easy to install package. Packages are available with an input disconnect switch and fast acting, current limiting fuses (ACS550-PD) or an input circuit breaker (ACS550-PC). Units with a circuit breaker disconnect at and above ratings of 30 HP at 208/240V and 75 HP at 480 & 600V are also equipped with fast acting, drive input fuses to limit damage to the drive and provide for the possibility of drive repair in the unlikely event that a short circuit or ground fault should develop within the input power structure of the drive.

Disconnects are externally operable and interlocked with the enclosure door. The cover mounted disconnect operating handle may be padlocked in the off position with up to three padlocks. The multilingual, alphanumeric drive control panel is provided on the cover of NEMA 1 and NEMA 12 enclosed devices, and on the drive within NEMA 3R enclosed units.

Vertical Wall Mount Enclosures

NEMA 1 and NEMA 12 enclosed ACS550-PC and PD Drives with Disconnect through 25 HP at 208/240V and 60 HP at 480 and 600V are provided in vertical wall mount enclosures. This unique construction provides a minimum footprint advantageous for use in overcrowded electrical rooms or mezzanines, or for direct mounting on machines or columns. Input and output conduit entry is at the bottom of the enclosure.



Oversized Wall Mounting Enclosures

For NEMA 1 and NEMA 12 enclosed ACS550-PC and PD Drives with Disconnect from 30 to 100 HP at 208/240V, 75 to 200 HP at 480 & 600V, wall mounting enclosures are sized to accommodate the field addition of components that users frequently desire to include at these higher horsepower ratings. A removable conduit plate is provided at the top of the enclosure.



Free Standing Packages

From 250 HP to 550 HP at 480V, ACS550-PC enclosures will accommodate the field installation of additional components. Where additional enclosure panel space is required, an auxiliary enclosure section is available. A molded case circuit breaker provides the disconnect means function while fast acting, current limiting drive input fuses provide short circuit protection. A removable conduit mounting plate is provided at the top of the enclosure.



NEMA 3R Enclosures

For outdoor applications, the ACS550 Drive with Disconnect is available in NEMA 3R enclosures up to 100 HP at 208/240V and 200 HP at 480 & 600V. Construction is sheet steel with a tough powder coat paint finish for corrosion resistance. A 100 watt, thermostatically controlled space heater and thermostatic control of the force ventilated cooling system are provided as standard.

ABB ACS550 Packaged Drives



ACS550 Packaged Drive with Bypass

ACS550 Packaged Drive with Bypass

The ACS550-CC is a complete Drive with Bypass Package that includes an ACS550 Adjustable Frequency Drive, a bypass function that allows the motor to be run at full voltage in the event the drive is shut down for service, a main disconnect means and branch circuit short circuit and ground fault protection. Complete, pre-engineered packages reduce time, effort and the cost of installing the popular drive bypass option.

The bypass function is configured entirely of standard industrial control components. It includes two electrically interlocked contactors, a motor overload relay, a control power transformer with primary and secondary fusing, and a cover mounted DRIVE-OFF-BYPASS selector switch.

Bypass is accomplished by means of the two contactors. One is the bypass contactor used to connect the motor directly to the power line. The other is the output contactor that disconnects the motor from the drive output when operating in the bypass mode. This prevents the “back feeding” that would occur if line voltage were applied to the drive output terminals. The drive output contactor and the bypass contactor are electrically interlocked to prevent simultaneous operation.

Externally Operated Devices

ACS550 Drive with Bypass Packages include an input circuit breaker with a door mounted external operating handle that is interlocked with the enclosure door and lockable in the OFF position with up to three padlocks. The multilingual, alphanumeric drive control panel is mounted on the door of the enclosure. An optional drive service switch (+F267) isolates the drive from the power source for service and provides superior functionality to a three-contactor arrangement.

Drive Input Fuses Standard

Fast acting, current limiting drive input fuses are provided as standard to limit damage and allow for possible drive repair if a short circuit or ground fault should develop in the drive input bridge. This is particularly pertinent for drives at the higher ratings where it is generally more economical to repair rather than replace the drive. The drive fuses are also intended to provide for immediate operation of the bypass function after such a fault.

Enclosure Options

Drive with Bypass Packages are available in NEMA 1 and NEMA 12 enclosures through 100 HP at 208/240V, 400 HP at 480V and 150 HP at 600V. For outdoor applications, NEMA 3R enclosed packages are available through 100 HP at 208/240V and 200 HP at 480 & 600V. NEMA 3R enclosures are sheet steel construction with a tough powder coat paint finish for corrosion resistance and include a 100 watt, thermostatically controlled space heater and thermostatic control of the force ventilated cooling system as standard.



NEMA 1 Wall Mount



NEMA 1 Floor Mount



NEMA 3R Floor Mount

Ratings, Types and Voltages

System Voltage	Base Drive Type Code	Frame Size	Nominal Ratings				Base Drive NEMA 1 Dim Ref UX1	Base Drive NEMA 12 Dim Ref UX12	Bypass NEMA 1 Dim Ref CX1	Bypass NEMA 12 Dim Ref CX12	Bypass NEMA 3R Dim Ref CX3R	Input Disconnect NEMA 1 Dim Ref PX1	Input Disconnect NEMA 12 Dim Ref PX12	Input Disconnect NEMA 3R Dim Ref PX3R
			Normal Duty		Heavy Duty									
			I _{2N} A	P _N HP	I _{2hd} A	P _{hd} HP								
208/240 V	ACS550-XX-04A6-2	R1	4.6	1	3.5	0.75	1	1	1	1	1	1	1	1
	ACS550-XX-06A6-2	R1	6.6	1.5	4.6	1	1	1	1	1	1	1	1	1
	ACS550-XX-07A5-2	R1	7.5	2	6.6	1.5	1	1	1	1	1	1	1	1
	ACS550-XX-012A-4	R1	11.8	3	7.5	2	1	1	1	1	1	1	1	1
	ACS550-XX-017-A2	R1	16.7	5	11.8	3	1	1	1	1	1	1	1	1
	ACS550-XX-024A-2	R2	24.2	7.5	16.7	5	2	2	3	3	2	2	2	2
	ACS550-XX-031A-2	R2	30.8	10	24.2	7.5	2	2	3	3	2	2	2	3
	ACS550-XX-046A-2	R3	46.2	15	30.8	10	3	3	4	5	3	3	3	3
	ACS550-XX-059A-2	R3	59.4	20	46.2	15	3	3	4	5	3	3	3	3
	ACS550-XX-075A-2	R4	74.8	25	59.4	20	4	4	6	6	4	4	4	4
	ACS550-XX-088A-2	R4	88	30	74.8	25	4	4	9	7	5	5	5	5
	ACS550-XX-114A-2	R4	114	40	88	30	4	4	9	7	5	5	5	5
	ACS550-XX-143A-2	R6	143	50	114	40	6	6	10	10	7	6	6	6
	ACS550-XX-178A-2	R6	178	60	150	50	6	6	10	10	7	6	6	6
480V	ACS550-XX-03A3-4	R1	3.3	1.5	2.4	1	1	1	1	1	1	1	1	1
	ACS550-XX-04A1-4	R1	4.1	2	3.3	1.5	1	1	1	1	1	1	1	1
	ACS550-XX-06A9-4	R1	6.9	3	5.4	2	1	1	1	1	1	1	1	1
	ACS550-XX-08A8-4	R1	8.8	5	6.9	3	1	1	1	1	1	1	1	1
	ACS550-XX-012A-4	R1	11.9	7.5	8.8	5	1	1	1	1	1	1	1	1
	ACS550-XX-015A-4	R2	15.4	10	11.9	7.5	2	2	2	2	2	2	2	2
	ACS550-XX-023A-4	R2	23	15	15.4	10	2	2	2	2	2	2	2	2
	ACS550-XX-031A-4	R3	31	20	23	15	3	3	4	4	3	3	3	3
	ACS550-XX-038A-4	R3	38	25	31	20	3	3	4	4	3	3	3	3
	ACS550-XX-045A-4	R3	44	30	38	25	3	3	4	5	3	3	3	3
	ACS550-XX-059A-4	R4	59	40	44	30	4	4	5	6	4	4	4	4
	ACS550-XX-072A-4	R4	72	50	59	40	4	4	5	6	4	4	4	4
	ACS550-XX-078A-4	R4	77	60	65	50	4	4	5	6	4	4	4	4
	ACS550-XX-097A-4	R4	96	75	77	60	4	4	6	7	5	5	5	5
	ACS550-XX-125A-4	R5	124	100	96	75	5	5	7	8	6	5	5	6
	ACS550-XX-157A-4	R6	157	125	124	100	6	6	10	9	7	6	6	6
	ACS550-XX-180A-4	R6	180	150	156	125	6	6	10	9	7	6	6	6
	ACS550-XX-246A-4	R6	245	200	192	150	6	6	11	10	8	6	6	6
	ACS550-XX-316A-4	R8	316	250	240	200	8		12	11		8	8	
	ACS550-XX-368A-4	R8	368	300	302	250	8		13	12		8	8	
ACS550-XX-414A-4	R8	414	350	368	300	8		13	12		8	8		
ACS550-XX-486A-4	R8	486	400	414	350	8		13	12		8	8		
ACS550-XX-526A-4	R8	526	450	477	400	8					8	8		
ACS550-XX-602A-4	R8	602	500	515	450	8					8	8		
ACS550-XX-645A-4	R8	645	550	590	500	8					8	8		
600V	ACS550-XX-02A7-6	R2	2.7	2	2.4	1.5	2	2	2	2	2	2	2	2
	ACS550-XX-03A9-6	R2	3.9	3	2.7	2	2	2	2	2	2	2	2	2
	ACS550-XX-06A1-6	R2	6.1	5	3.9	3	2	2	2	2	2	2	2	2
	ACS550-XX-09A0-6	R2	9	7.5	6.1	5	2	2	2	2	2	2	2	2
	ACS550-XX-011A-6	R2	11	10	9	7.5	2	2	2	2	2	2	2	2
	ACS550-XX-017A-6	R2	17	15	11	10	2	2	2	2	2	2	2	2
	ACS550-XX-022A-6	R3	22	20	17	15	3	3	4	4	3	3	3	3
	ACS550-XX-027A-6	R3	27	25	22	20	3	3	4	4	3	3	3	3
	ACS550-XX-032A-6	R4	32	30	27	25	4	4	5	6	4	4	4	4
	ACS550-XX-041A-6	R4	41	40	32	30	4	4	5	6	4	4	4	4
	ACS550-XX-052A-6	R4	52	50	41	40	4	4	5	6	4	4	4	4
	ACS550-XX-062A-6	R4	62	60	52	50	4	4	5	6	4	4	4	4
	ACS550-XX-077A-6	R6	77	75	62	60	6	6	8	9	6	6	6	6
	ACS550-XX-099A-6	R6	99	100	77	75	6	6	8	9	6	6	6	6
	ACS550-XX-125A-6	R6	125	125	99	100	6	6	10	9	6	6	6	6
	ACS550-XX-144A-6	R6	144	150	125	125	6	6	10	9	6	6	6	6

Notes:

xx = construction designations:

U1 = Base Drive - Wall mount

U2 = Base Drive - Floor mount

PD = Packaged Drive with Switch and Fuse

PC = Packaged Drive with Circuit Breaker

CC = Packaged Drive with Bypass

Dimensions



ACS550-UX, NEMA 1/UL Type 1

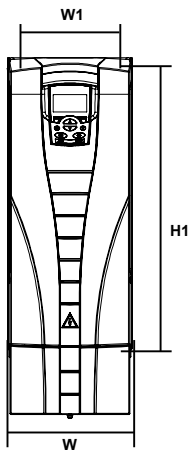

Wall Mount (UX1-1 - UX1-6)

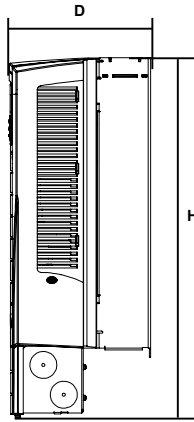

Floor Mount (UX1-7 - UX1-8)

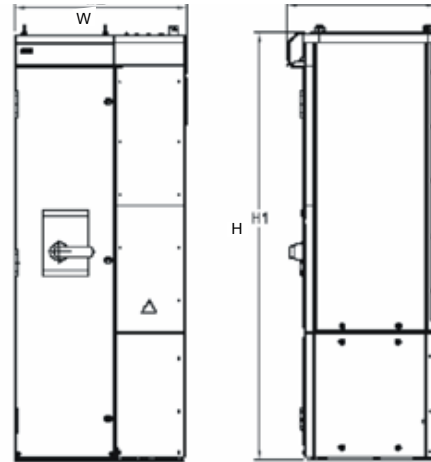

Dim	Frame	Mounting Dimensions			Shipping Dimensions				Dimension Drawing	
		H1	W1	Mounting Hardware	H	W	D	Weight		
UX1-1	R1	12.5	3.9	#10	14.5	4.9	8.3	14.3	3AUA0000001559 - sheet 1	
UX1-2	R2	16.4	3.9	#10	18.5	4.9	8.7	19.5	3AUA0000001560 - sheet 1	
UX1-3	R3	18.6	6.3	#10	23	8	9.1	35	3AUA0000001571 - sheet 1	
UX1-4	R4	22.8	6.3	#10	27.1	8	10.3	53	3AUA0000001572 - sheet 1	
UX1-5	R5	23.2	9.4	0.25	29	10.5	11.3	75	3AUA0000004629 - sheet 1	
UX1-6	R6	26.6	10.4	0.25	35	11.9	15.8	152	3AUA0000004633 - sheet 1	
UX1-7	R7	Free Standing			NA	59.2	24	19.5	430	Consult Factory
UX1-8	R8	Free Standing			NA	83.9	31.5	23	827	Consult Factory

ACS550-UX, NEMA 12/UL Type 12

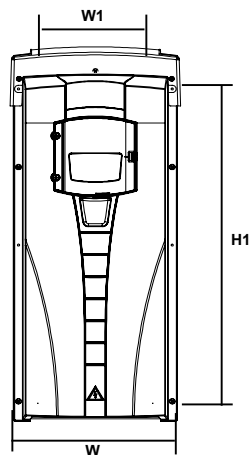

Wall Mount (UX12-1 - UX12-6)

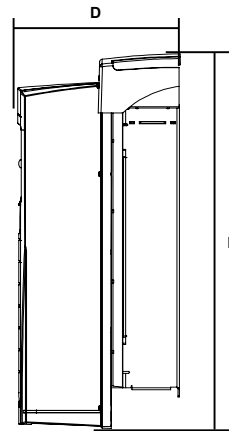

Dim	Frame	Mounting Dimensions			Shipping Dimensions				Dimension Drawing
		H1	W1	Mounting Hardware	H	W	D	Weight	
UX12-1	R1	12.5	3.9	#10	18.1	8.4	9.2	17.6	3AUA0000004031 - sheet 1
UX12-2	R2	16.4	3.9	#10	22.1	8.4	9.6	24.3	3AUA0000004032 - sheet 1
UX12-3	R3	18.6	6.3	#10	24.8	10.1	10	37.5	3AUA0000004029 - sheet 1
UX12-4	R4	22.8	6.3	#10	29.9	10.1	11.2	57.3	3AUA0000004043 - sheet 1
UX12-5	R5	23.2	9.4	0.25	30.5	14.5	12.2	92.6	3AUA0000004634 - sheet 1
UX12-6	R6	26.6	10.4	0.25	36.4	16.1	16.7	190	3AUA0000004635 - sheet 1

Dimensions



ACS550-Cx NEMA 1 / UL Type 1

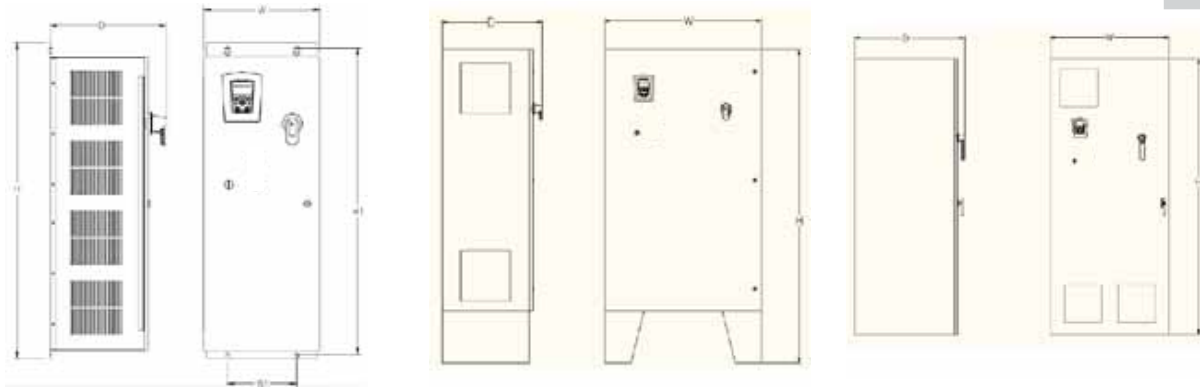

Wall Mount (CX1-1 - CX1-8)

Wall Mount (CX1-9 - CX1-11)

Floor Mount (CX1-12 - CX1-13)

Dim	Mounting Dimensions			Shipping Dimensions				Dimension Drawing
	H1	W1	Mounting Hardware	H	W	D	Weight	
CX1-1	36.2	8.2	0.375	37.3	13.7	13.7	77	3AUA0000012797 - sheet 4
CX1-2	36.2	8.2	0.375	37.3	13.7	13.7	82	3AUA0000012797 - sheet 4
CX1-3	53.2	10	0.375	54.3	16.3	14.6	108	3AUA0000012798 - sheet 4
CX1-4	53.2	10	0.375	54.3	16.3	14.6	134	3AUA0000012798 - sheet 4
CX1-5	53.2	10	0.375	54.3	16.3	14.6	168	3AUA0000012798 - sheet 4
CX1-6	61.7	13	0.375	62.8	19.3	19.2	198	3AUA0000012799 - sheet 4
CX1-7	61.7	13	0.375	62.8	19.3	19.2	262	3AUA0000012799 - sheet 4
CX1-8	61.7	13	0.375	62.8	19.3	19.2	340	3AUA0000012799 - sheet 4
CX1-9	Free Standing		Ø0.56	74.1	35	20.7	278	3AUA0000012800 - sheet 4
CX1-10	Free Standing		Ø0.56	74.1	35	20.7	419	3AUA0000012800 - sheet 4
CX1-11	Free Standing		Ø0.56	72	36	23	545	3AUA0000024944 - sheet 4
CX1-12	Free Standing		N/A	84	36	33.4	1276	3AUA0000013236 - sheet 4
CX1-13	Free Standing		N/A	84	60	33.4	1459	3AUA0000013223 - sheet 4

ACS550-Cx NEMA 12 / UL Type 12

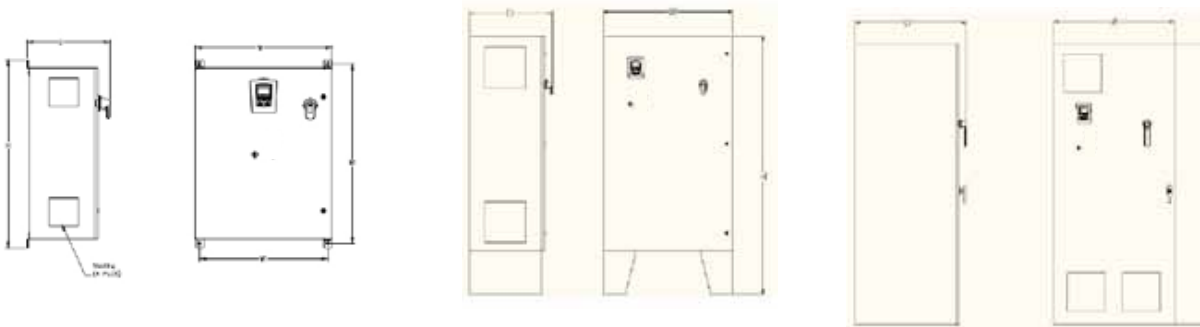

Wall Mount (CX12-1 - CX12-9)

Wall Mount (CX12-10)

Floor Mount (CX12-11 - CX12-13)

Dim	Mounting Dimensions			Shipping Dimensions				Dimension Drawing
	H1	W1	Mounting Hardware	H	W	D	Weight	
CX12-1	25.5	16.5	0.375	27	18	14.5	79	3AUA0000012801 - sheet 4
CX12-2	25.5	16.5	0.375	27	18	14.5	84	3AUA0000012801 - sheet 4
CX12-3	31.5	22.5	0.375	33	24	14.5	112	3AUA0000012802 - sheet 4
CX12-4	31.5	22.5	0.375	33	24	14.5	141	3AUA0000012802 - sheet 4
CX12-5	37.5	28.5	0.375	39	30	14.5	172	3AUA0000012803 - sheet 4
CX12-6	37.5	28.5	0.375	39	30	14.5	205	3AUA0000012803 - sheet 4
CX12-7	49.5	34.5	0.375	51.4	36	22.5	260	3AUA0000012804 - sheet 4
CX12-8	49.5	34.5	0.375	51.4	36	22.5	324	3AUA0000012804 - sheet 4
CX12-9	49.5	34.5	0.375	51.4	36	22.5	401	3AUA0000012804 - sheet 4
CX12-10	Free Standing		Ø0.56	72	36	23	545	3AUA0000012805 - sheet 4
CX12-11	Free Standing		N/A	84	36	33.4	1276	3AUA0000013237 - sheet 4
CX12-12	Free Standing		N/A	84	60	33.4	1459	3AUA0000013224 - sheet 4

Dimensions



ACS550-Cx UL Type 3R / NEMA 3R

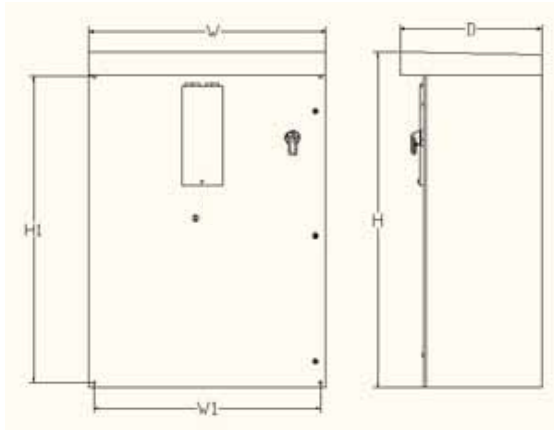

Wall Mount (CX3R-1-7)

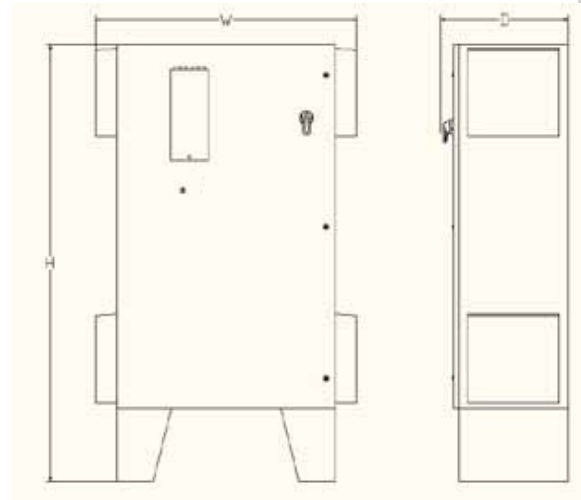

Floor Mount (CX3R-8)

Dim	Mounting Dimensions			Shipping Dimensions				Dimension Drawing
	H1	W1	Mounting Hardware	H	W	D	Weight	
CX3R-1	22.5	16.5	0.375	27	18	13.5	82	3AUA0000060121 - sheet 4
CX3R-2	22.5	16.5	0.375	27	18	13.5	88	3AUA0000060121 - sheet 4
CX3R-3	28.5	22.5	0.375	33	24	13.5	145	3AUA0000060122 - sheet 4
CX3R-4	34.5	28.5	0.375	39	30	15.5	213	3AUA0000060123 - sheet 4
CX3R-5	46.5	34.5	0.375	51	36	21.5	268	3AUA0000060124 - sheet 4
CX3R-6	46.5	34.5	0.375	51	36	21.5	332	3AUA0000060124 - sheet 4
CX3R-7	46.5	34.5	0.375	51	36	21.5	409	3AUA0000060124 - sheet 4
CX3R-8	Free Standing		0.375	72	43	20.7	554	3AUA0000060125 - sheet 4

ACS550-Px UL Type 1 / NEMA 1



Wall Mount (PX1-1 - PX1-4)

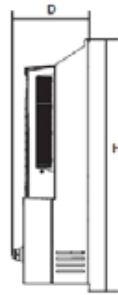

Wall Mount (PX1-5 - PX1-6)

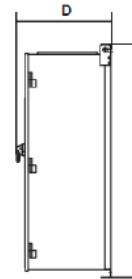
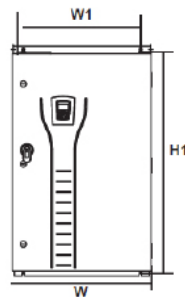

Floor Mount (PX1-8)

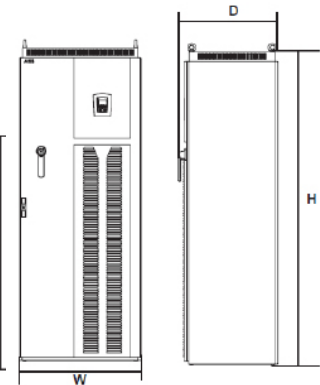

Dim	Mounting Dimensions			Shipping Dimensions				Dimension Drawing
	H1	W1	Mounting Hardware	H	W	D	Weight	
PX1-1	28	3.9	0.25	28.7	7.8	11.2	33	3AUA0000008216 - sheet 1
PX1-2	32	3.9	0.25	32.6	7.8	11.6	42	3AUA0000008218 - sheet 1
PX1-3	38.7	6.3	0.25	39.9	10.2	11.9	75	3AUA0000008220 - sheet 1
PX1-4	44	6.3	0.25	45.2	10.2	13.1	95	3AUA0000008221 - sheet 1
PX1-5	46.3	23.6	0.375	47.7	28.1	19	267	3AUA0000021148 - sheet 1
PX1-6	46.3	23.6	0.375	47.7	28.1	19	359	3AUA0000021148 - sheet 1
PX1-8	Free Standing		Ø0.63	83.7	31.7		25.9	3AUA0000021152 - sheet 1

Dimensions



ACS550-Px UL Type 12 / NEMA 12

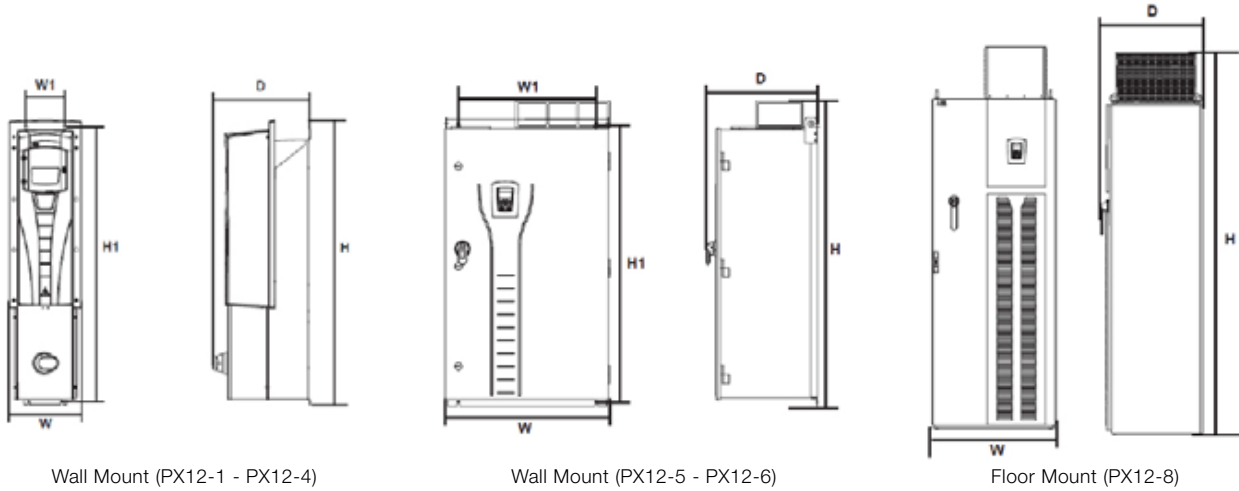

Dim	Mounting Dimensions			Shipping Dimensions				Dimension Drawing
	H1	W1	Mounting Hardware	H	W	D	Weight	
PX12-1	28	3.9	0.25	29.3	8.7	11.2	37	3AUA0000008216 - sheet 2
PX12-2	32	3.9	0.25	33.2	8.7	11.6	46	3AUA0000008218 - sheet 2
PX12-3	38.7	6.3	0.25	40.6	10.5	11.9	79	3AUA0000008220 - sheet 2
PX12-4	44	6.3	0.25	45.8	10.5	13.1	99	3AUA0000008221 - sheet 2
PX12-5	46.3	23.6	0.375	54.3	28.1	19	267	3AUA0000021149 - sheet 1
PX12-6	46.3	23.6	0.375	54.3	28.1	19	359	3AUA0000021149 - sheet 1
PX12-8	Free Standing		Ø0.63	93.6	31.7	25.9	838	3AUA0000021153 - sheet 1

ACS550-Px UL Type 3R / NEMA 3R

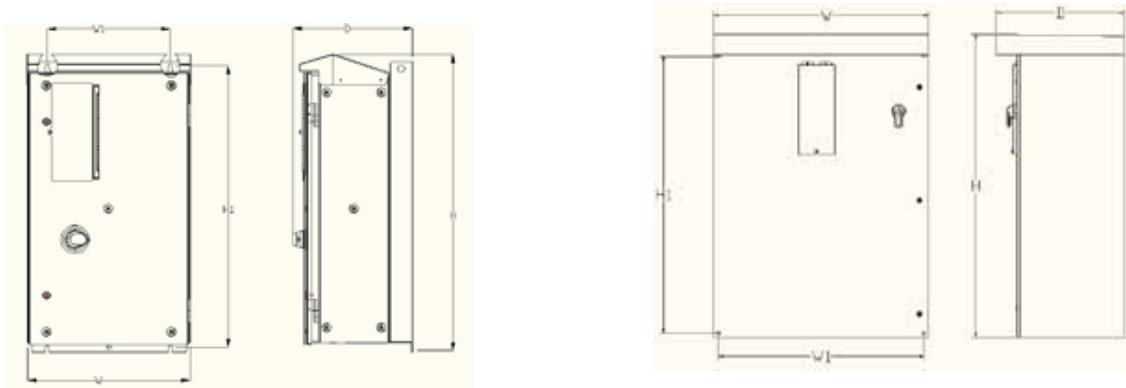

Dim	Mounting Dimensions			Shipping Dimensions				Dimension Drawing
	H1	W1	Mounting Hardware	H	W	D	Weight	
PX3R-1	31.9	12.6	0.375	34	17.8	13.5	128	3AUA0000016377 - sheet 1
PX3R-2	31.9	12.6	0.375	34	17.8	13.5	134	3AUA0000016377 - sheet 1
PX3R-3	36.1	15.7	0.375	38.1	20.9	15.3	176	3AUA0000016380 - sheet 1
PX3R-4	36.1	15.7	0.375	38.1	20.9	15.3	194	3AUA0000016380 - sheet 1
PX3R-5	34.5	28.5	0.375	39	30	15.5	203	3AUA0000060123 - sheet 2
PX3R-6	46.5	34.5	0.375	51	36	21.5	203	3AUA0000060124 - sheet 2



Contact us

ABB Inc.

Low Voltage Drives
16250 W. Glendale Drive
New Berlin, WI 53151 USA
Phone: (800) 752-0696
Fax: (262) 785-0397
Web: www.abb.us/drives

ABB Inc.

Low Voltage Drives- Canada
2117, 32nd Avenue
Lachine, QC H8T 3J1
Tel: (514) 420-3111 ext: 3505
Fax: (514) 420-3138
Web: www.abb.com

ACS560-PHT C01U-EN REV1 Effective 03/26/2010 Subject to change without notice.